

Factor 5

Features

- » 2-way compact enclosure
- » 5" high stability speaker
- » 1" soft dome ferrofluid cooled tweeter
- » 80 W power handling
- » 80 Hz - 23 kHz response
- » Flexible mounting options
- » Horizontal or vertical use
- » Broad coverage



INTRODUCTION

The D.A.S. FACTOR 5 is a vented 2-way loudspeaker system designed to bring high performance from a reduced size cabinet.

APPLICATIONS

The FACTOR 5 is so versatile that it is equally at home as a near field monitor sitting on top of a console as in multi-media applications or ambient music.

DESCRIPTION

The low end utilizes a 5" speaker that was specifically designed for this system, and shows unusually stable behaviour at high drive levels for a speaker this size.

The 1" soft dome tweeter for the top end is ferrofluid cooled for maximum power handling and low power compression.

The cabinet box is built out of high-density polypropylene and features extensive internal bracing, resulting in minimum vibration. Additionally, a perforated steel grille protects the components.

Model FACTOR 5T houses a multi-tap transformer for use in distributed applications.

MOUNTING

The back of the cabinet houses a female thread for the AX-5/8 optional wall and ceiling mounting bracket, which enables swivel and horizontal or vertical angling. Alternatively, two openings are provided for simple fixing to a wall via an L-shaped nail.

SPECIFICATIONS

RMS (Average) Power Handling^R:	80 W
Programme Power Handling^P:	160 W
Peak Power Handling^K:	>320 W
Frequency Response^F:	80 Hz - 23 kHz
Nominal Impedance:	8 Ω
Minimum Impedance^I:	5.5 Ω
On-axis Sensitivity 2.83 V / 1 m^S:	90 dB SPL
Nominal -6 dB Beamwidths^B:	140° Horizontal
(average, 500 Hz to 10 kHz)	120° Vertical
Speech Coverage Angles^C:	155° Horizontal x 155° Vertical
Enclosure Material:	Mineral loaded polypropylene
Colour:	Black or white
Transducers/Replacement Parts:	Bass: G-5/GM G-5
	HF: TWT-5/GM TWT-5
Connector:	Spring loaded push terminals
Dimensions (H x W x D):	23 x 15 x 15.5 cm (9.1 x 5.9 x 6.1 in)
Weight:	2.8 kg (6.2 lbs)
Shipping Weight (pair):	6.4 kg (14.1 lbs)
Accessories (optional):	AX-5 wall/ceiling mount

^R Based on a 2 hour test using a 6 dB crest factor signal bandlimited according to IEC 268-1 (1985). All power ratings are referred to the nominal impedance.

^P Conventionally 3 dB higher than the RMS measure, although this already utilizes a programme signal.

^K Corresponds to the signal crests for the test described in ^R.

^F As per IEC 268-5 (1989), re. a one octave band centered at 2 kHz. Half space anechoic.

^I In practice cable and connector impedance has to be added to all impedance values.

^S For the 2 kHz one octave band.

^B Average of one-third octave band measures.

^C There is currently no standard method of averaging the beamwidth with frequency characteristics into a single meaningful figure, which impedes comparisons across manufacturers and very often even product lines. This, our own, criterion weighs the -6 dB coverage angles from one-octave bands according to their contribution to speech intelligibility. One and one-third octave bands comply to ANSI S1.11-1986.

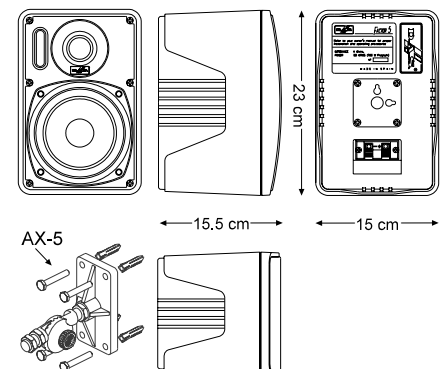

Frequency Response

Figure 1 shows the fundamental frequency response at 1 m of a unit radiating to a half space anechoic environment and driven by a 2.83 V swept sine signal.

Impedance

Figure 2 shows impedance with frequency.

Distortion

Figure 3 shows the Total Harmonic Distortion Plus Noise (solid), Second Harmonic Distortion (dashed) and Third Harmonic Distortion (dotted) curves for a unit driven at 10% of its nominal power handling rating.

Beamwidth

Figure 4 shows the -3, -6 and -10 dB horizontal (solid) and vertical (dashed) beamwidth with frequency curves. -6 dB ones are shown with thicker traces for clarity.

Axial Directivity Q(R_θ) and D_i

Figure 5 shows the above characteristics with frequency.

Polar Response

Figure 6 shows the one octave band horizontal (solid) and vertical (dashed) polars for the indicated frequencies. Full scale is 50 dB, 5 dB per division.

NOTES. 1.Frequency response: referred to 1 m; low end obtained through the use of near field techniques;one-third octave smoothed for correlation with human hearing. 2.In practice, cable and connector impedance need to be added. 3.Harmonic distortion components are not plotted beyond 20 kHz; THD+N is 22 Hz - 22 kHz filtered; near-field techniques used. 4.Directivity characteristics plotted with respect to frequency are the average within the one-third octave bands of centre frequencies noted by the marks at the bottom of the graphs, but are joined up for display purposes. All other characteristics plotted vs. frequency use 1/24th octave resolution. Notches of less than 1 dB below goal level may be ignored when calculating beamwidths. 5.Directivity factor and index were computed from two degree resolution vertical and horizontal polars using sinusoidal weighting. 6.Polars were acquired by placing the unit on a computer controlled turntable inside our anechoic chamber. Measurement distance was 3 m. Product improvement through research and development is a continuous process at D.A.S. Audio. All specifications subject to change without notice.

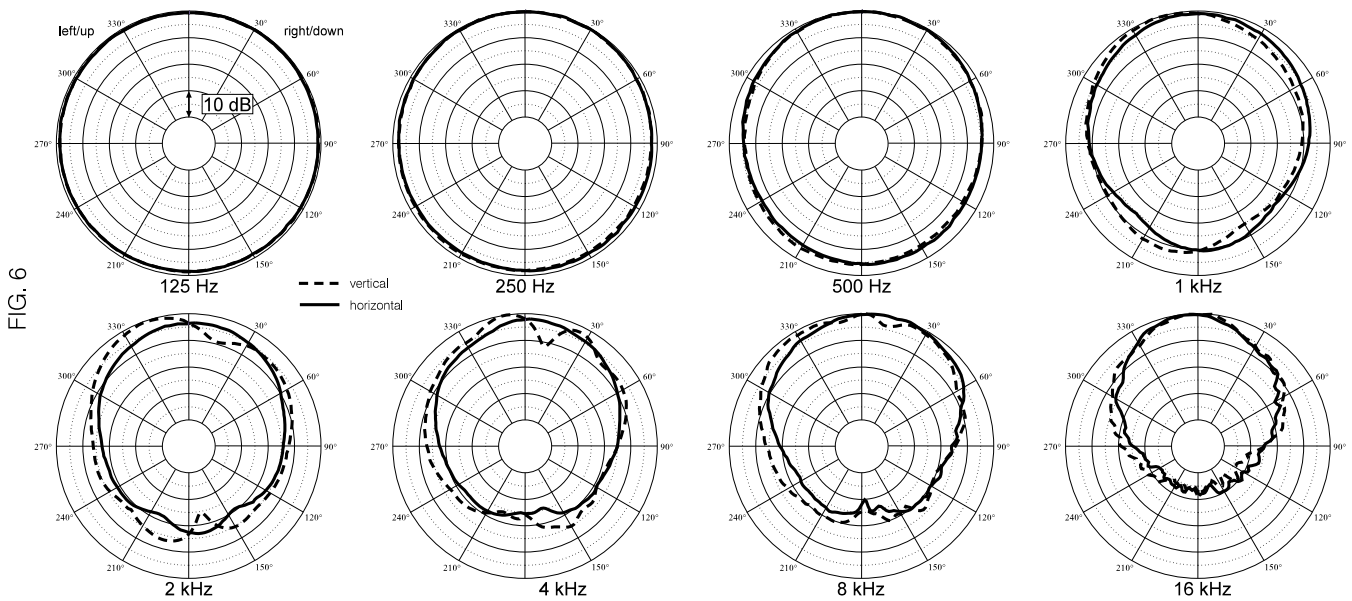
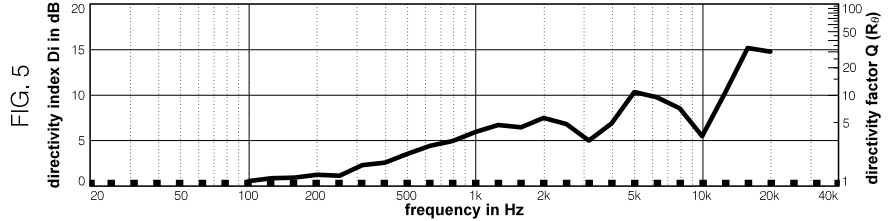
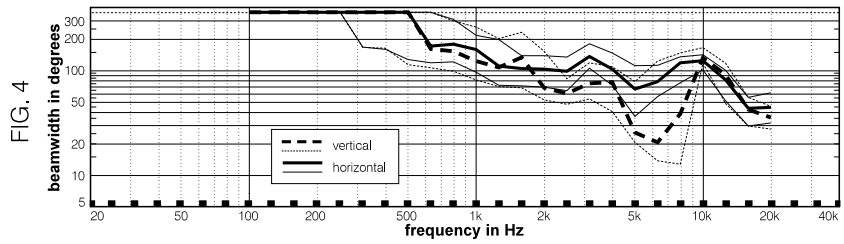
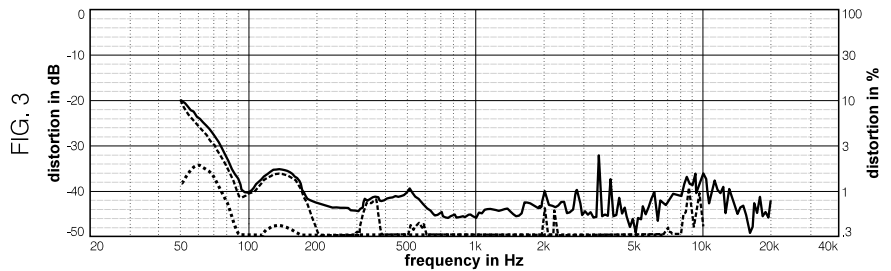
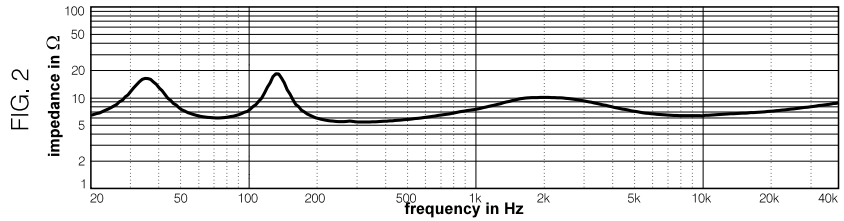
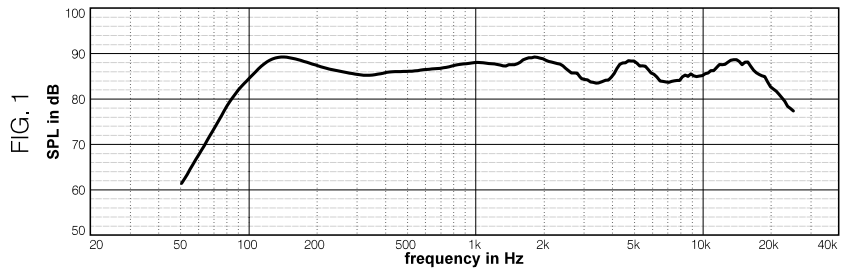

D.A.S. Audio, s.a. - C/. Islas Baleares, 24 - 46988 Pol. Ind. Fuente del Jarro - Valencia, SPAIN
 Tel. 96 134-0525 - Tel. Intl. +34-96-134-0860 - Fax. 96 134-0607 - Fax. Intl +34-96-134-0607 - <http://www.dasaudio.com>
 D.A.S. Audio of America, Inc. - 6970 N.W. 50th St. - Miami, FL. 33166 - U.S.A.
 Tel. 305 436 0521 - Fax. 305 436 0528